

Material	Schwerer Stahl
Oberfläche	verzinkt
Im Lieferumfang	Haken Befestigungsplatte
Max. Haltekraft	410 daN
Gewicht	0.3 kg
Hub	-
Spanndruck	270 daN

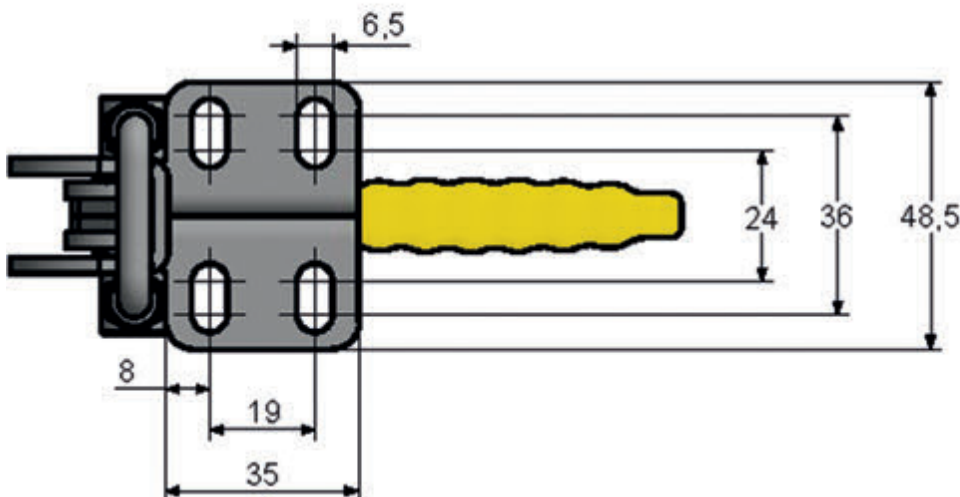
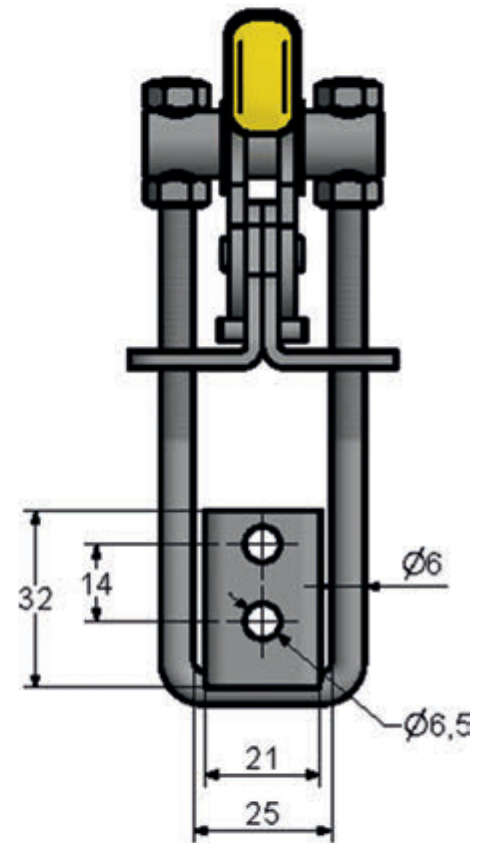
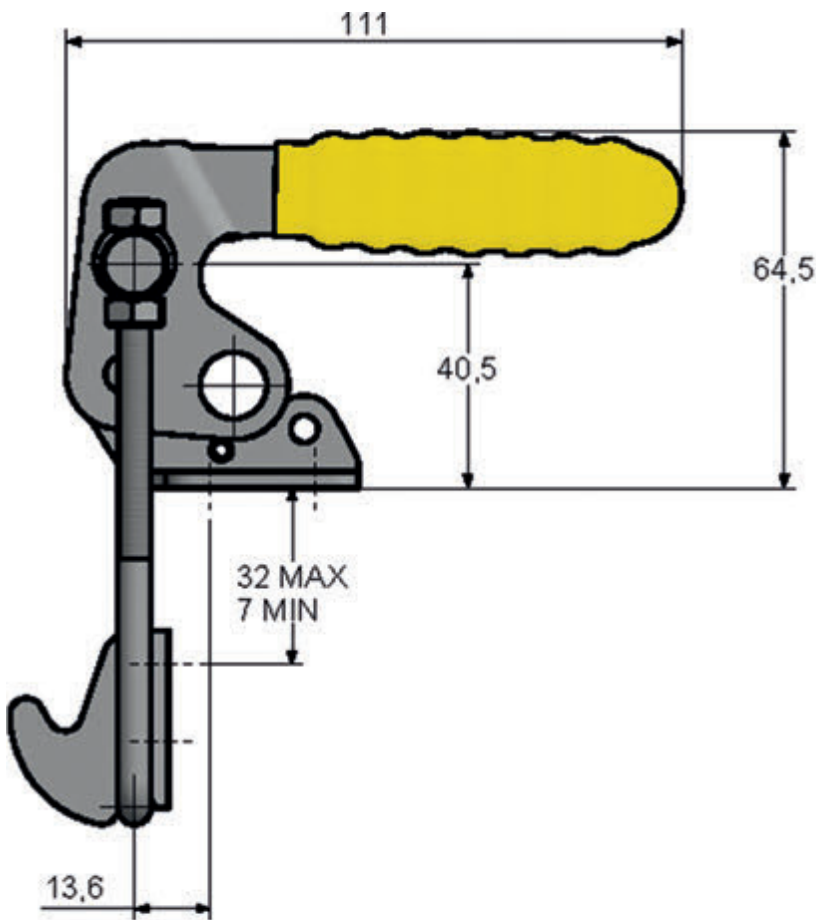

HAKENSPANNER