

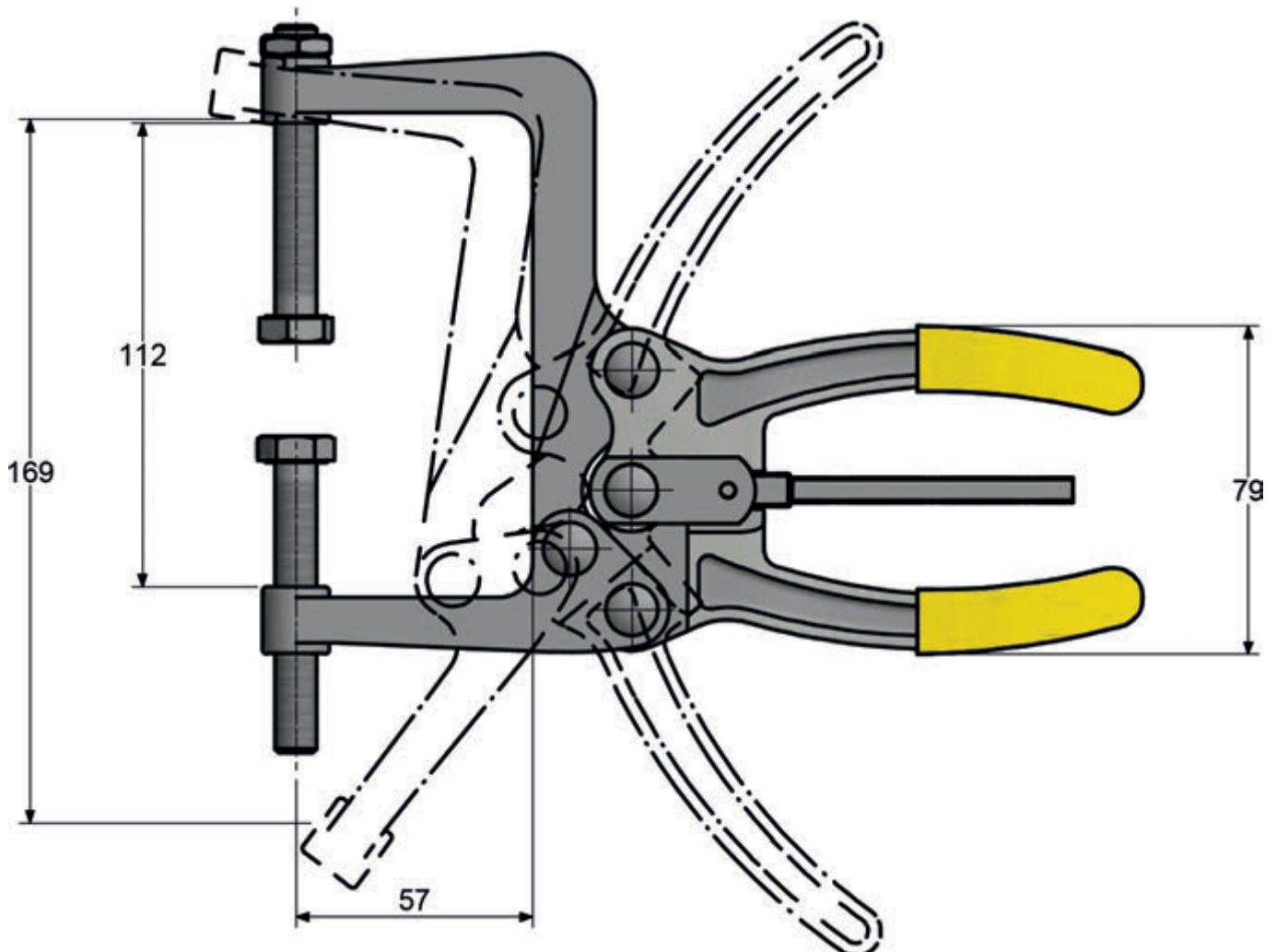

# TS - G - 545 - JW112

<b>Material</b>	Schwerer Stahl Gehärtete Stifte und Buchsen
<b>Oberfläche</b>	verzinkt
<b>Im Lieferumfang</b>	10x70 mm Spindeln
<b>Max. Haltekraft</b>	545 daN
<b>Gewicht</b>	1.1 kg
<b>Hub</b>	-
<b>Spanndruck</b>	170 daN

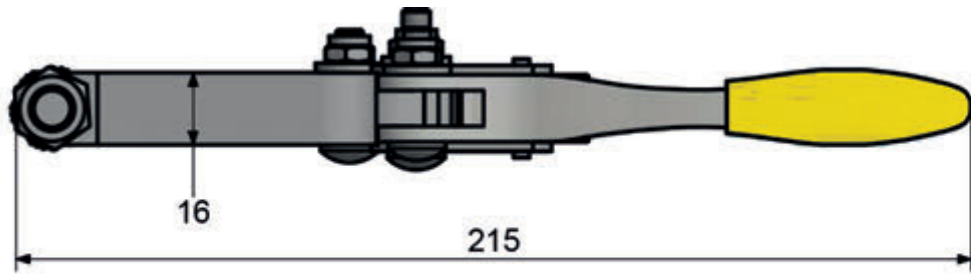

ZANGENWIRKUNG