

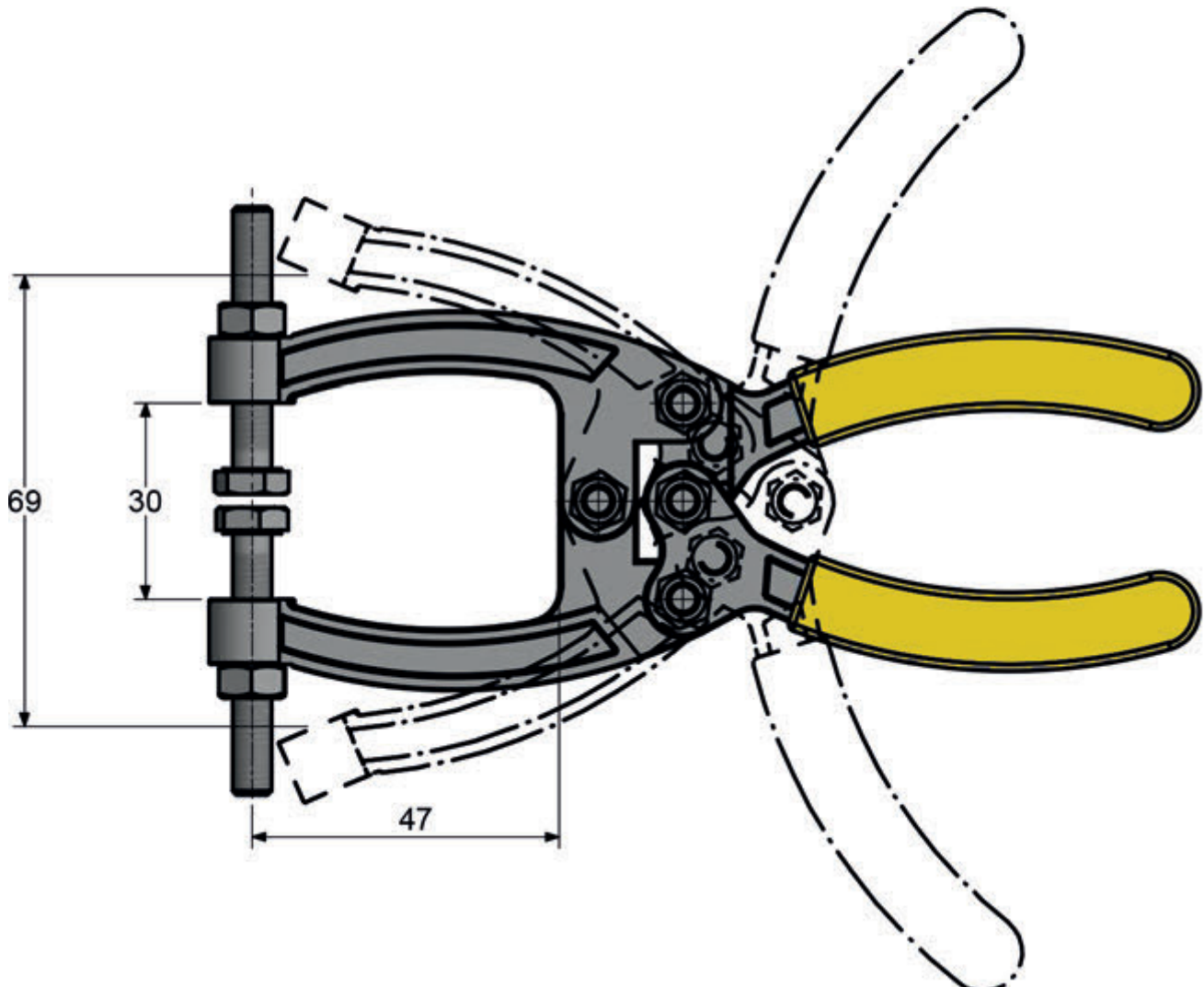

# TS - G - 150 - JW30

<b>Material</b>	Schwerer Stahl Gehärtete Stifte und Buchsen
<b>Oberfläche</b>	verzinkt
<b>Im Lieferumfang</b>	6x40 mm Spindeln
<b>Max. Haltekraft</b>	150 daN
<b>Gewicht</b>	0.27 kg
<b>Hub</b>	-
<b>Spanndruck</b>	80 daN

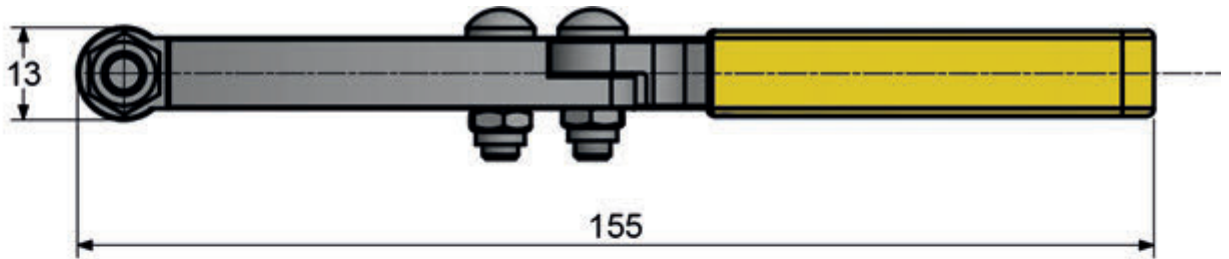

ZANGENWIRKUNG